

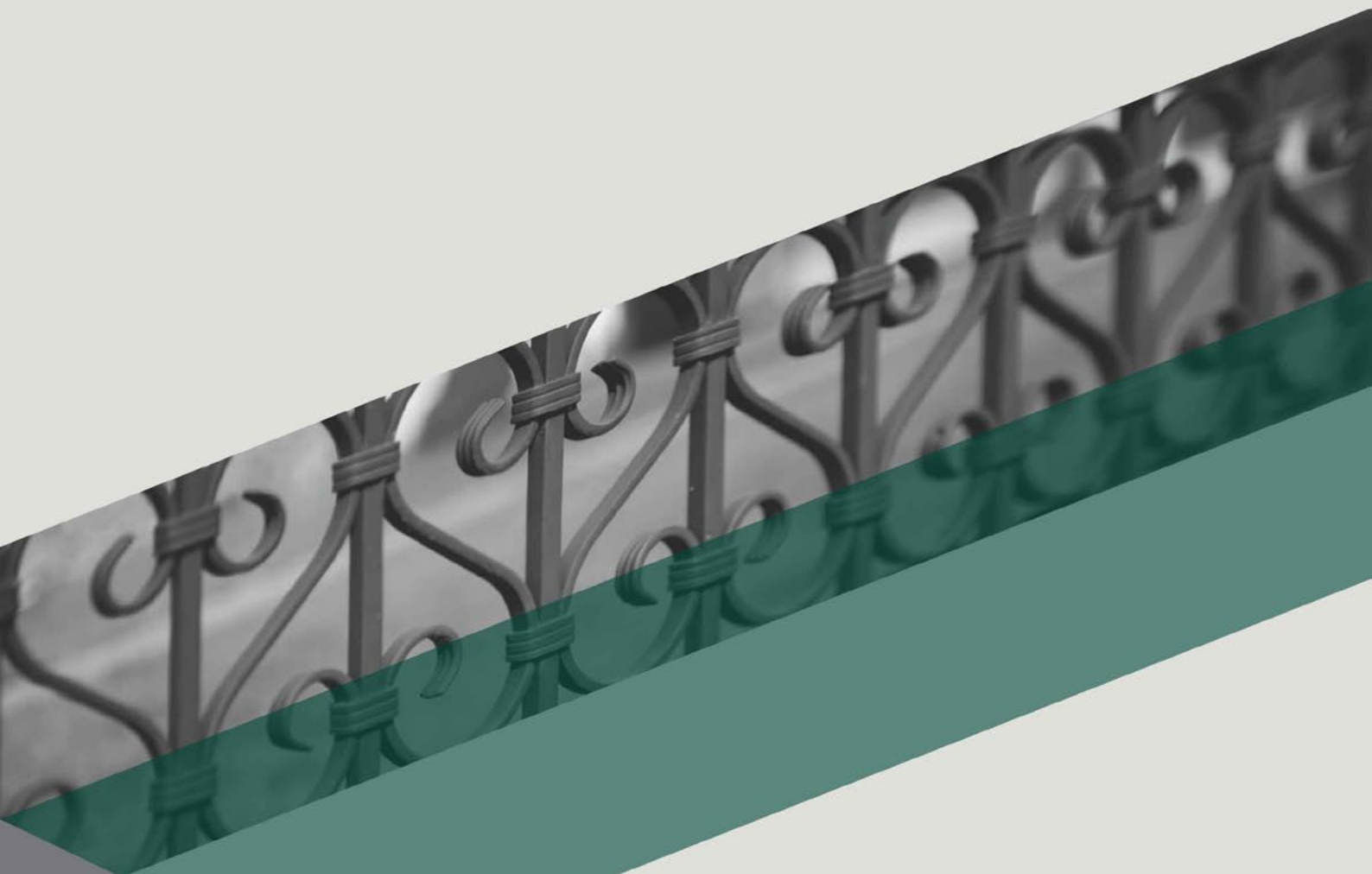

INOX  
LEŠKO



Brodec 2, Vratišinec  
40315 Mursko Središće  
091 183 06 82  
[leskodejan@gmail.com](mailto:leskodejan@gmail.com)



# FIX

	Art.	Material						D (mm)	H (mm)	B (mm)	Gmax / Art.							
		Fe	Zn	INOX							10 kg	20 kg	25 kg	30 kg	40 kg	50 kg	60 kg	80-250 kg
	D4/41-21	✓				✓	21	110	28				✓					
	D4/41-25	✓				✓	25	130	35					✓				
	D4/41-30	✓				✓	30	155	45						✓			
	D4/47-100	✓			✓		20	105	20				✓					
	D4/47-122	✓			✓		24	125	24					✓				
	D4/47-146	✓			✓		30	142	30							✓		
	D4/47-195	✓			✓		30	195	30							✓		
	D4/68-130	✓			✓		29	130	29							✓		
	D4/11-40	✓				✓	10	40	13	✓								
	D4/11-60	✓				✓	10	60	14	✓								
	D8/11-60		✓			✓	10	60	12		✓							
	D4/11-80	✓				✓	12	80	16		✓							
	D4/11-100	✓				✓	14	100	18			✓						
	D8/11-100		✓			✓	14	100	16				✓					
	D4/11-120	✓				✓	16	120	20				✓					
	D8/11-120		✓			✓	16	120	18					✓				
	D4/11-140	✓				✓	16	140	21					✓				
	D4/11-160	✓				✓	20	160	25					✓				
	D8/11-160		✓			✓	18	160	20						✓			
	D4/11-180	✓				✓	20	180	27							✓		
D4/11-200	✓				✓	22	200	29							✓			
	D4/60-70	✓			✓		20	70	20					✓				
	D4/60-90	✓			✓		27	90	27						✓			
	D4/13-L	✓				✓	28	103	26								80 kg	
	D4/14-L	✓				✓	28	190	26								120 kg	
	D4/32-20	✓			✓		20	90	60x60								100 kg	
	D4/32-24	✓			✓		24	100	70x70								150 kg	
	D4/52	✓				✓	44	35+52	-								250 kg	



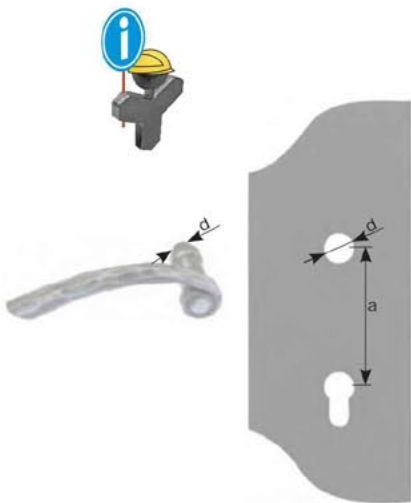

D1/14-AL



D1/14-H2-S



D1/02



D1/14A-T90



D2/29  
L110, b20, Al black



D2/30  
L130, b25, PVC



D5/08  
D63, Cast iron



D1/19





L- left R- right

a=90 mm d max=18,5 mm

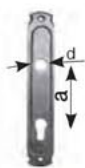

**D1/02**  
240x40, t3, d18



**D2/01 -T**  
L160, d17,5  
Zn-black



**D12/07-90**  
265x60, t3



**D1/14AL**  
265x105, t3, d18,5

**D1/14AR**  
265x105, t3, d18,5



**D2/05T-Zn**  
L140, d17,5  
Zn



**D2/51**  
L121,d19,Fe



**D1/14A-S**  
265x105, t3



**D2/07-Zn**  
L150, d17,5  
Zn



**D5/09**  
D70



**D1/14H2**  
265x105, t2, d18,5

**D1/14H3**  
265x105, t3, d18,5



**D2/11-Zn**  
L130, d17,5  
Zn



**D1/32K**  
D68, t3, d18



**D1/14H2-S**  
265x105, t2

**D1/14H3-S**  
265x105, t3



**D2/28-Zn**  
L145, d17,5  
Zn



**D1/32F**  
D68, t3, d18



**D1/34-S-L-t2**  
270x160, t2

**D1/34-S-R-t2**  
270x160, t2



**D2/34-Zn**  
L150, d17,5  
Zn



**D1/39F**  
66x31,PVC



**D0/01**  
d18, L74



**D0/04**  
d17,5, L67

L- left R- right

a=90 mm d max=22 mm



**D1/14AL-T90**  
268x117,t3, d20

**D1/14AR-T90**  
268x117,t3, d20



**D1/35-S**  
285x110,t2,5



**D1/45K**  
D50, t2, d20



**D2/11-Fe**  
L130,d19,5



**D1/34-L-t2**  
270x160,t2, d22

**D1/34-R-t2**  
270x160,t2, d22



**D1/18-90**  
245x47,t2,5, d20



**D1/45F**  
D50, t3



**D2/52**  
L142,d19,Fe



**D1/64-L-85**  
315x135,t2, d20, 85

**D1/64-R-85**  
270x160,t3, d22, 85



**D1/55-90**  
260x60,t3, d20



**D1/46K**  
D50, t4, d21



**D2/53A**  
L148,d19,Fe



**D1/35-L-90**  
280X100,t2,5, d22

**D1/35-R-90**  
280X100,t2,5, d22



**D0/03 Zn**  
D70,8x8



**D1/46F**  
D50, t4



**D5/11-Fe**  
D60,d19



**D1/57F**  
D68,t8  
cast iron



**D5/11-Zn**  
D60,d19, Zn



**D1/57K**  
D68,t8  
cast iron

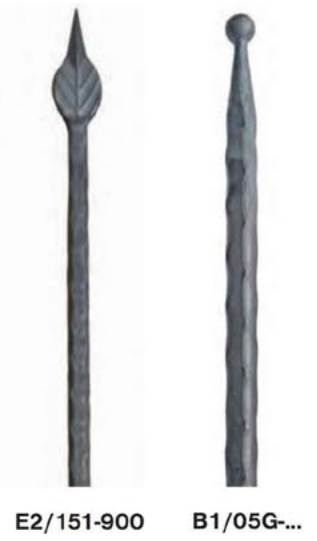
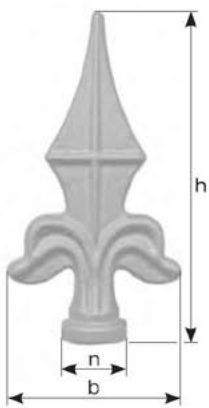



**B1/04G-150**  
n12x12

**B1/04G-350**  
n12x12

**B1/04G-500**  
n12x12



**E2/102-90**  
b32, n23

**E2/102-125**  
b39, n24,5



**E2/128A-140**  
b40, n29

**E2/128A-165**  
b57,5, n27

**E2/128A-180**  
b60, n29,5

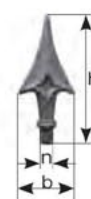

**E2/141-155**  
b67, n15,5



**B1/04H-150**  
n12x12

**B1/04H-350**  
n12x12

**B1/04H-500**  
n12x12



**E2/105-98**  
b35, n20

**E2/105-135**  
b40, n25



**E2/131-88**  
b28,5, n21,5

**E2/131P-120**  
b35, n30



**E2/142-130**  
b59, n12



**B1/04P-150**  
n12x12

**B1/04P-350**  
n12x12

**B1/04P-500**  
n12x12

**B1/04P-900**  
n12x12



**E2/108-155**  
b68, n15,5

**E2/108A-130**  
b60, n12



**E2/133-80**  
b44, n15

**E2/133P-80**  
b42, n15

**E2/133-140**  
b70, n26

**E2/133A-115**  
b58, n21,5



**E2/144B-150**  
b40, n12x12

**E2/144-155**  
b35-40, n14x14



**E2/115-152**  
b48, n12



**E2/133G-115**  
b58, n20,5

**E2/133G-140**  
b69, n26



**E2/145-200**  
b19, n12x12



**B1/05G-150**  
n12x12

**B1/05G-350**  
n12x12

**B1/05G-500**  
n12x12



**E2/121-125**  
b57, n12



**E2/135-120**  
b42,5, n12x12



**E2/146-60**  
b30, n22x22

**E2/146A-95**  
b25, n11,5x11,5



**B1/05G-A-150**  
b15, decorated,  
12x12

**B1/05G-A-350**  
b15, decorated,  
12x12

**B1/05G-A-500**  
b15, decorated,  
12x12



**E2/122-130**  
b57, n12



**E2/136-125**  
b63, n24

**E2/136A-80**  
b46, n21



**E2/147-110**  
b50, n25

**E2/147-125**  
b59, n30



**E2/161-140**  
b50, n13



**E2/137-105**  
b53, n18x21

**E2/137-120**  
b68, n24x24



**E2/147G-110**  
b50, n25



**B1/05H-A-350**  
decorated, 12x12



**E2/125-82**  
b20x20, n15x15

**E2/125-125**  
b27x27, n20x20



**E2/140-150**  
b49, n12x12



**E2/148A-76**  
b43, n16

**E2/148-100**  
b56, n19



**E2/149A-110**  
b54, n25

**E2/149A-125**  
b62, n29

**E2/149-140**  
b70, n34



**E2/150-200**  
b60, n35



**E2/151-150**  
b29, n12x12

**E2/151-900**  
b29, P/035-12x12



**E2/152-150**  
b30, n12x12

**E2/152-900**  
b30, P/035-12x12



**E2/153-165**  
b58, n24



**E2/155-160**  
b23, n23x23



**E2/156-140**  
b60, n14x14



**E2/158-135**  
b25, n30



**E2/159-125**  
b55 n19,5



**E2/163-150**  
b65, n15



**E2/164A-70**  
b60, n12x12



**E2/171-55**  
b35,5x35,5,  
n 16x16



**E2/175-107**  
b26, n15x15

**E2/175-142**  
b29, n16,5x16,5

**E2/175-148**  
b34, n20x20



**E2/176-82**  
b16, n16x16

**E2/176-110**  
b19, n19x19



**E2/179-134**  
b64, n26



**E2/180**  
b20, n20x20



**E2/182 - 120**  
b35, n12x12



**E2/183-115**  
b22x22,  
n17,5x17,5



**E2/185 - 150**  
b42, n12x12



**E2/186 - 100**  
b44, n12

**E2/186 - 120**  
b55, n16



**E2/191-180**  
b90, n32



**E2/192-180**  
b85, n35



**E2/193-180**  
b90, n352



**E2/196-205**  
b68, h265, n35



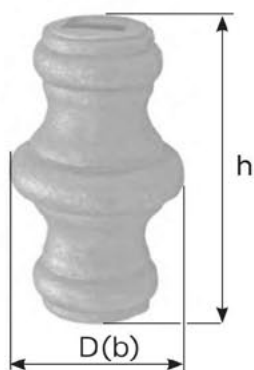
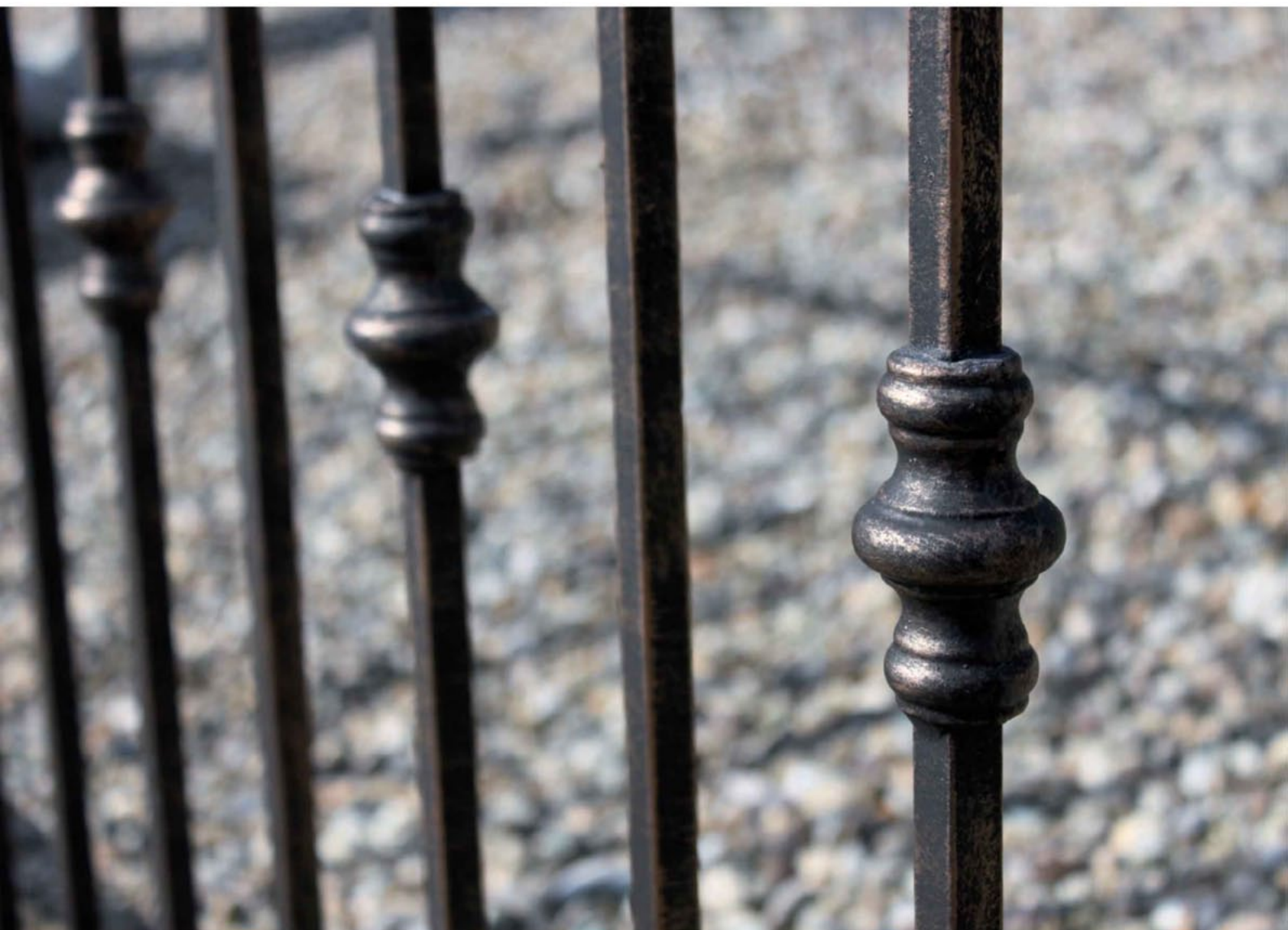

**E4/009A-12,5x12,5**  
h63, D36

**E4/009A-14,5x14,5**  
h67, D45

**E4/009A-16,5x16,5**  
h67, D44



**E4/010-13x13**  
h53, D44

**E4/010-15x15**  
h53, D44



**E4/012-12,5x12,5**  
h68, b41x41

**E4/012-14,5x14,5**  
h68, b41x41

**E4/012-16,5x16,5**  
h67, b40x40



**E4/013-12,5x12,5**  
h21, b34x34

**E4/013-14,5x14,5**  
h21, b38x38



**E4/016-12,5x12,5**  
h21, D40

**E4/016-14,5x14,5**  
h21, D40

**E4/016-16,5x16,5**  
h21, D40



**E4/009-D12,5**  
h65, D37



**E4/023-12,5x12,5**  
h44, b38x38



**E4/027-16x16**  
h145, b43x43



**E4/027P-16x16**  
h70, b36x36





E/361



E/365-...



E/372-...



E2/254-...



E2/258-...



E2/261-...



E2/229-...



E2/275-...



E2/219-...



























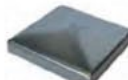

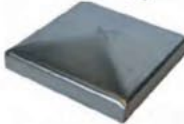



B1/03-JPL  
-30x30x2  
B1/03-JPL  
-40x40x2



B1/03P/-201  
-30x30x2,5  
B1/03P/-201  
-40x40x2,5





	<b>E2/258-20x20</b> <b>E2/258-25x25</b> <b>E2/258-30x30</b> <b>E2/258-40x40</b> <b>E2/258-50x50</b> <b>E2/258-60x60</b> <b>E2/258-60x40</b> <b>E2/258-70x70</b> <b>E2/258-80x80</b> <b>E2/258-100x100</b>		<b>B1/50-80x80x8</b> t8, 4xd10 <b>B1/50-100x100x8</b> t8, 4xd10		<b>E2/219</b> 100x100, t10
			<b>B1/50-120x120x8</b> t8, 4xd10 <b>B1/50-150x150x8</b> t8 4xd12		<b>E2/219-26x26</b> 100x100, 27x27, t10 <b>E2/219-31x31</b> 100x100, 31x31, t10
	<b>E2/280-12x12</b>		<b>SOLID</b> <b>E/361-15</b> <b>E/361-20</b> <b>E/361-25</b> <b>E/361-30</b> <b>E/361-35</b> <b>E/361-40</b> <b>E/361-50</b> <b>E/361-60</b>		<b>E2/226-13-50</b> 52x52, 13x13, t6 <b>E2/226-21-0-70</b> 70x70, 21x21, t7
	<b>E2/254-30x30</b> t1,5 <b>E2/254-40x40</b> t1,5 <b>E2/254-50x50</b> t1,5 <b>E2/254-60x60</b> t1,5 <b>E2/254-80x80</b> t1,5 <b>E2/254-100x100</b> t1,5 <b>E2/254-120x120</b> t1,5				<b>E2/237</b> 100x100, t,2,5
			<b>HOLLE</b> <b>E/365-40</b> <b>E/365-50</b> <b>E/365-60</b> <b>E/365-70</b> <b>E/365-80</b> <b>E/365-100</b> <b>E/365-120</b> <b>E/365-150</b>		<b>E2/237-13</b> 76,5x76,5, 13x13, t,2,5
	<b>E2/254-40x40Zn</b> t1,5 <b>E2/254-50x50Zn</b> t1,5 <b>E2/254-60x60Zn</b> t1,5 <b>E2/254-80x80Zn</b> t1,5 <b>E2/254-100x100Zn</b> t1,5 <b>E2/254-120x120Zn</b> t1,5 <b>E2/254-150x150Zn</b> t1,5				<b>E2/228-13-40</b> 40x40, 13x13, h18
					<b>E2/228-41-80</b> 80x80, 41x41, h17
	<b>E2/261-40x40</b> 40x40,h47, D40, t0,55 <b>E2/261-50x50</b> 50x50,h58, D50, t0,55 <b>E2/261-60x60</b> 60x60,h69, D80, t0,55 <b>E2/261-80x80</b> 80x80,h89, D80, t0,55 <b>E2/261-100x100</b> 100x100,h110, D100, t0,55		<b>E/372-20</b> <b>E/372-25</b> <b>E/372-30</b> <b>E/372-50</b>		<b>E2/229-12x12</b> 48x48, 13x13, h13 <b>E2/229-14x14</b> 50x50, 15x15, h13 <b>E2/229-16x16</b> 50x50, 17x17, h13 <b>E2/229-20x20(50x50)</b> 50x50, 20x20, h14 <b>E2/229-25x25(77x77)</b> 77x77, 31x31, h16,5 <b>E2/229-25x25</b> 77x77, 26x26, h17,5 <b>E2/229-30x30</b> 80x80, 31x31, h16,5 <b>E2/229-40x40</b> 80x80, 41x41, h15,5
			<b>E2/243</b>		
	<b>E2/262-50x50</b> t1,3, h70 <b>E2/262-60x60</b> t1,5, h84 <b>E2/262-80x80</b> t1,5, h135 <b>E2/262-100x100</b> t2,5, h140 <b>E2/262-120x120</b> t2,5, h150		<b>E2/214-26x26</b> 60x60, h19, t4 <b>E2/214-31x31</b> 60x60, h19, t4		<b>E2/275-12x12</b> 44x44, 14x14, h20, t1 <b>E2/275-20x20</b> 57x57, 22x22, h22, t1 <b>E2/275-30x30</b> 80x80, 31,5x31,5, h30, t1 <b>E2/275-40x40</b> 100x100, 42x42, h30, t1 <b>E2/275-50x50</b> 100x100, 52x52, h30, t1
			<b>E2/214</b> 60x60, h16		

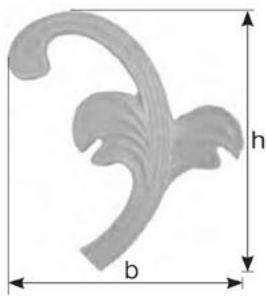
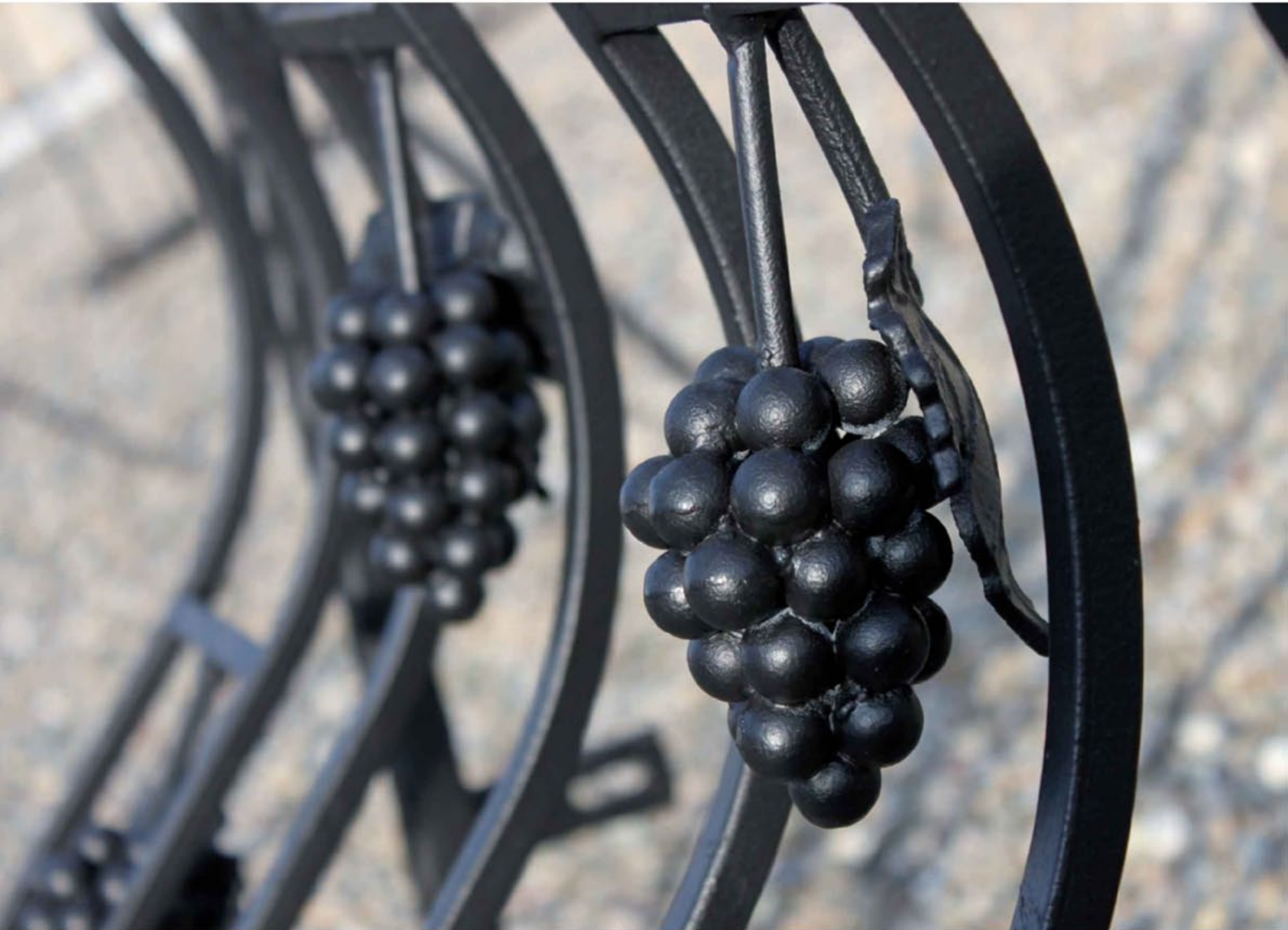

E2/307L...



E2/307R...



E2/335...













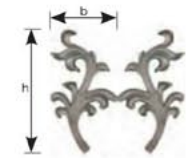











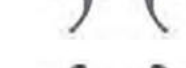

E2/337-A170

















L- left R- right

-   **E2/010P-68**  
D68, t1,5
-   **E2/010P-97**  
D97, t1,5
-   **E2/010P-120**  
D120, t1,2
-  **E2/015A-65**  
D65, t3
-  **E2/026-60**  
D60, t2,5
-  **E2/027-60**  
D60, t1
-  **E2/042-35**  
D35x40, t1,2
-  **E2/042-45**  
D45x43, t1,2
-  **E2/042-60**  
D60x45, t1,2
-  **E2/236**  
h140, b145, t4
-  **E2/227-155**  
h155, b77, t3,5
-   **E2/272-120**  
h120, b50, t4
-  **E2/272-145**  
h145, b61, t4
-  **E2/276-95**  
D95, t1,5
-   **E2/300L-90-t2**  
h90, b65, t2
-  **E2/300R-90-t2**  
h90, b65, t2
-   **E2/307L-115-t2**  
h115, b40, t2
-   **E2/307L-90-t1,5**  
h90, b30, t1,5
-  **E2/307R-115-t2**  
h115, b40, t2
-  **E2/307R-90-t1,5**  
h90, b30, t1,5

-  **E2/329L-230**  
h230, b130, t5
-  **E2/329R-230**  
h230, b130, t5
-  **E2/434-50**  
h70, b50, t2
-  **E2/434-70**  
h95, b34, t2
-   **E2/345L-120**  
h120, b88, t5
-  **E2/345R-120**  
h120, b102, t5
-   **E2/347L-140**  
h130, b102, t5
-  **E2/347R-140**  
h130, b102, t5
-   **E2/348L-155**  
h145, b55, t5
-  **E2/348R-155**  
h145, b55, t5
-   **E2/349L-240**  
h240, b60, t4
-  **E2/349R-240**  
h240, b60, t4
-   **E2/371L-230**  
h230, b130, t4
-  **E2/371R-230**  
h230, b130, t4
-   **E2/372L-200**  
h200, b95, t4
-  **E2/372R-200**  
h200, b95, t4
-   **E2/373L-180**  
h180, b85, t4
-  **E2/373R-180**  
h180, b85, t4
-   **E2/374L-165**  
h165, b125, t4
-  **E2/374R-165**  
h165, b125, t4
-   **E2/376L-150**  
h150, b130, t4
-  **E2/376R-150**  
h150, b130, t4
-   **E2/377L-50**  
h95, b50, t2,5
-  **E2/377R-50**  
h95, b50, t2,5
-   **E2/416L-115**  
h115, b99, t2
-  **E2/416R-115**  
h115, b99, t2

-  **E2/328-V**  
h295, b54, t2,5
-  **E2/332-70**  
h70, b/, t0,5
-  **E2/332-82**  
h82, b/, t0,5
-  **E2/335-105**  
h105, b95, t1
-  **E2/337-A170**  
h295, b54, t2,5
-  **E2/432**  
h170, b52
-   **E2/335-120**  
h120, b73, t4
-  **E2/335-125**  
h125, b73, t4
-   **E2/335-135**  
h135, b85, t4
-  **E2/335-155**  
h155, b110, t4
-   **E2/344-115**  
h115, b75, t2
-  **E2/344-155**  
h155, b110, t2
-  **E2/344-195**  
h195, b135, t2
-  **E2/415-85**  
h85, b50, t2
-  **E2/415-113**  
h113, b65, t2
-  **E2/415-145**  
h145, b83, t2
-   **E2/423-70**  
h70, b70, t2
-  **E2/423-95**  
h95, b90, t2
-   **E2/423-125**  
h125, b110, t2
-  **E2/423-150**  
h150, b140, t2
-   **F/60-02**  
h170, b90, t2
-  **F/60-03**  
h140, b74, t2
-  **F/60-04**  
h95, b50, t2



E/103TOP-...



E/203TOP-...



E/241TOP-...



E/301S-270



E/305TOP-270



E/333TOP-275



E/323-185-2



E/349TOP-125



E/340-120



E/352TOP-120x90



E/315J-70



E/384J





"C" scroll	detail „TOP“			detail „S“			detail „R“		
material	art	h	b	art	h	b	art	h	b
12x6	E/103TOP-80		55						
	E/103TOP-95		60	E/103S-100		60			
	E/103TOP-100		65	E/103S-120		70			
	E/103TOP-115		75	E/103S-130		75			
	E/103TOP-120		75				E/103R-120		75
	E/103TOP-130		80						
	E/103TOP-140		80	E/103S-160		80			
	E/103TOP-150		80						
E/103TOP-230		125							
12x12	E/104TOP-120		80						
"S" scroll									
material	art	h	b	art	h	b	art	h	b
12x6	E/203TOP-200		85				E/203R-200		85
	E/203TOP-230		100				E/203R-230		100
	E/203TOP-280		110						
material	art	h	b	art	h	b	art	h	b
12x6	E/241TOP-150		70/40	E/241S-150		70/40			
	E/241TOP-170		75/45	E/241S-170		80/47			
	E/241TOP-200		85/50				E/241R-200		85/45
	E/241TOP-230		120/60	E/241S-220		100/60			
	E/241TOP-260		115/65	E/241S-270		105/70			
	E/241TOP-300		130/70						
	E/241TOP-330		130/65						
"O" scroll									
material	art	h	b	art	h	b	art	h	b
12x6	E/349TOP-125								
							E/340-100		
							E/340-120		
12x12						E/340-130			
							E/347-100		
							E/347-120		
"6" scroll									
material	art	h	b	art	h	b	art	h	b
12x6	E/352TOP-100		75						



E/301S-270  
270X65,  
P/030-12x6



E/305TOP-270  
260x65, 12x6



E/333TOP-275  
260x75, 12x6



E/323-185-2  
200x95, 12x6



E/315J-70  
130x70, 12x12



E/384J  
110x90, 12x6



E/340-100  
E/340-120  
E/340-130

E/347-100  
E/347-120





E/055...



E/062...



P/055...



P/062...



NIT/N...



NIT/6x30-32

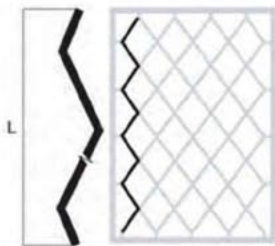

P/060-12x6

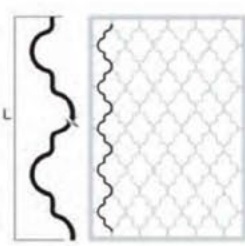

P/070-12x6

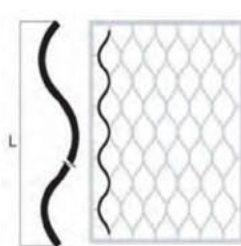

P/080-12x6

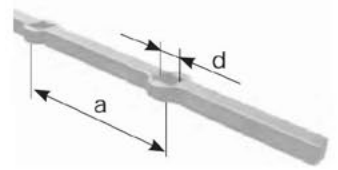

P/097-12x12





	<b>12x12-C</b>	<b>12x12-R</b>	<b>18x12-R</b>	<b>24x12-C</b>	<b>24x12-R</b>
	<b>E/055-12x12C</b>	<b>E/055-12x12-R</b>	<b>E/055-18x12-R</b>	<b>E/055-24x12-C</b>	<b>E/055-24x12-R</b>
		<b>E/062-12x12-R</b>	<b>E/062-18x12-R</b>		<b>E/062-24x12-R</b>

**umakov**  
YouTube

- NIT/N-14**  
D14/d5, t1,2
- NIT/N-17**  
D17/d5, t1,2
- NIT/N-25**  
D25/d10, t2,5
- NIT/6x30-32**  
D10, d6, L30-32
- NIT/04-6x30**  
D18, d6, h36
- Z1/07E**  
70x200,  
P/002-30x5

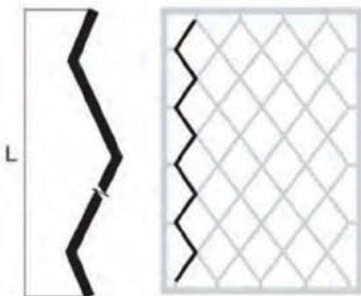

**P/060-12x6**  
12x6, L2350, 1m<sub>2</sub>=5,5pcs

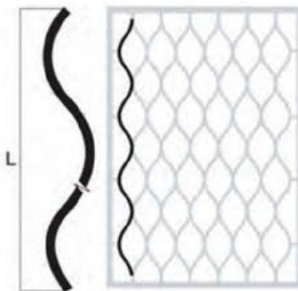

**P/070-12x6**  
12x6, L2650, 1m<sub>2</sub>=5,5pcs  
**P/070-12x12**  
12x12, L2600, 1m<sub>2</sub>=5,5pcs

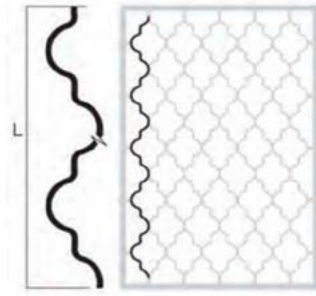

**P/080-12x6**  
12x6, L2400, 1m<sub>2</sub>=5,5pcs

**P/086A-12x12**  
12x12, P/035-12x12, a125, L2000



**P/096-14x14**  
14x14, d15x15, a140, L2000



**P/097-12x12**  
12x12, d13x13, a120, L2000

**P/097-14x14**  
14x14, d15x15, a140, L2000

**P/097-16x16**  
16x16, d17x17, a150, L2000







F/53-250



F/50-710



F/27-530



F/28A-L



F/62A

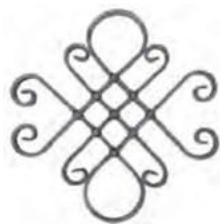

F/52-410



F/94





**F1/06**  
135x950, 15x8



**F/41A-450**  
450x450,  
12x6



**F/78**  
580x600,  
12x12



**F/27-530**  
530x420,  
P/035A-12x12



**F/45E**  
h180, D27



**F/79**  
720x350,  
12x6



**F/28A-L**  
1120x680  
P/111-D12  
**F/28A-R**  
1120x680  
P/111-D12



**F/50-710**  
710x640,  
P/123-16x8



**F/89**  
385x390,  
10x5



**F/29**  
580x440/  
alt. 620x380,  
16x8



**F/52-410**  
400x410,  
16x8



**F/86-16x8**  
370x880,  
16x8



**F/30A**  
800x700  
16x8



**F/53-250**  
250x250,  
10x5

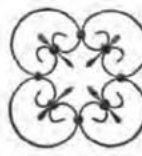

**F/90**  
385x390,  
10x5



**F/33B-240**  
240x240  
11x6



**F/56-300**  
D300,  
12X12



**F/94**  
225x765,  
14x6

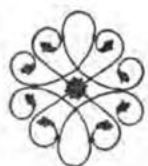

**F/34A-550**  
550x610,  
16x8



**F/62A**  
555X350,  
10x10



**F/95**  
290x1112,  
14x6



**F/35-575**  
575x400,  
16x8



**F/68A**  
d12, h950



**F/103**  
250x250,  
20x4



**F/38B-240**  
240x240,  
P/030.11x6

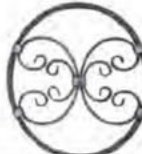

**F/104**  
375x300,  
12x12/12x6



**F/33-240**  
240X240,  
12x6



**F/76-340**  
340x340,  
12x6



**F/105**  
480x410,  
16x8



**E/241ZL-410**  
410x205,  
P/123-16x8

**E/241ZR-410**  
410x205,  
P/123-16x8



**F/51A-460**  
P/122-12x12



**F/81**  
320x280



**F/27R-530**  
530x420,  
P/035-12x12



**F/54**  
D14, b55, h115



**F/91A**  
565x400,12x12



**F/27-SMALL**  
330x290,12x6



**F/55-400**  
400x300,  
11,5x11,5



**F/106-L**  
880x830, D12



**F/33-E**  
127x25,12x6

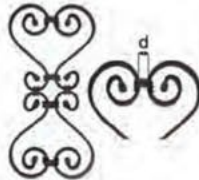

**F/72**  
410x200, 12x6,  
d12x12, b60



**F/106-R**  
880x830, D12



**F/38-240**  
240x240,  
P/030-12x6mm



**F/74**  
800x440, 16x8



**F/107-L**  
1400X385,14x8  
**F/107-R**  
1400X385,14x8



**F/44-A-800**  
810x190, D14



**F/75**  
415x425, 12x6



**T10/824-L**  
740x315,16x8  
**T10/824-R**  
740x315,16x8



**F/45A**  
L220, D46



**F/77A**  
870x870, 16x8



**T10/820A**  
12x6, b330,  
h870



**F/50-710**  
710x640, 16x8



**F/80**  
655X655, 12x12



**F/39A-950**  
1120x1060,  
P/111-D12



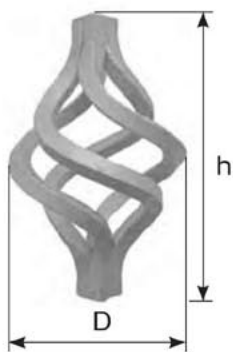
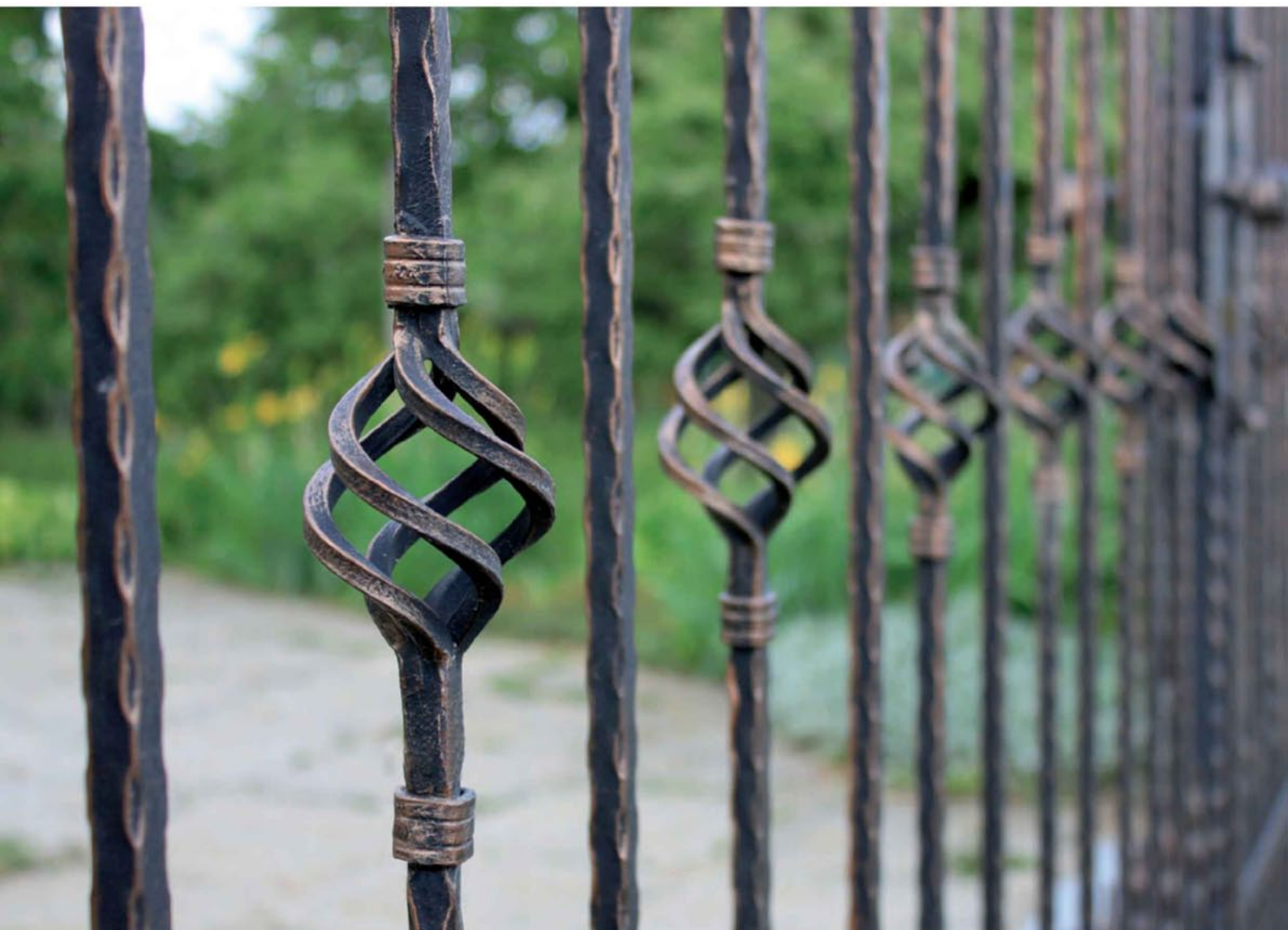

**E/501-10**  
h115, D45, 10x10

**E/501-10,5-12**  
h130, 10,5-12

**E/501-12**  
h130, D58, 12x12

**E/501-14**  
h130, D63, 14x14

**E/501-16**  
h145, D62, 16x16

**E/501B-20**  
h160, D95, 20x20



**E/585-12**  
h130, D60, 12x12

**E/585-15**  
h150, D70, 15x15

**E/585-18**  
h180, D100, 18x18



**E/582-6**  
D70, 6x6



**E4/029-45**  
h45, D30, n24



**E4/029-70**  
h73, D50, n48



**E4/028-85**  
h85, D48, n40x40



**E4/008-90**  
h93, D53

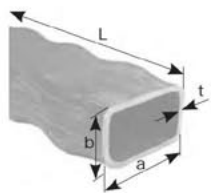



**a x b x t - L**

P/201-12x12x1,5-3M  
 P/201-16x16x1,5-3M  
 P/201-20x20x2-3M  
 P/201-25x25x2,5-3M  
 P/201-30x30x2,5-3M  
 P/201-30x30x2,5-6M  
 P/201-40x40x2,5-3M  
 P/201-40x40x2,5-6M  
 P/201-50x50x2,5-3M  
 P/201-60x60x2,5-3M  
 P/201-80x80x2,5-3M  
 P/201-100x100x3-3M  
 P/201-120x120x3-3M

**a x b - L**

12x6-3M  
 12x6-6M  
 14x6-6M  
 16x6-6M  
 30x5-3M  
 30x5-6M  
 40x5-6M  
 40x8-6M

**a x b - L**

P/002-20x5-3M  
 P/002-25x5-3M  
 P/002-30x5-3M  
 P/002-30x5-6M  
 P/002-40x5-3M  
 P/002-50x5-3M

P/201-30x20x2-3M  
 P/201-30x40x2,5-3M  
 P/201-30x50x2,5-3M  
 P/201-40x20x2-3M  
 P/201-60x40x2,5-3M

**a x b - L**

12x12-3M  
 12x12-6M  
 14x14-6M  
 16x16-3M  
 16x16-6M

P/041-25x8-3M  
 P/041-25x8-5,8M  
 P/041-30x8-3M  
 P/041-30x8-5,8M  
 P/041-40x9-3M

P/201D-20x20x1,5-3M  
 P/201D-25x25x1,5-3M  
 P/201D-30x30x1,5-3M  
 P/201D-40x40x1,5-3M

**a x b - L**

12x12x1,5-6M  
 14x14x1,5-6M  
 16x16x1,5-6M  
 30x30x2,5-6M  
 40x40x2,5-6M  
 50x50x2,5-6M  
 60x60x2,5-6M  
 80x80x3-6M  
 100x100x3-6M

P/035A-12x12-3M  
 P/035A-12x12-6M  
 P/035A-14x14-3M  
 P/035A-16x16-3M  
 P/035A-16x16-6M  
 P/035A-25x25-3M  
 P/035A-30x30-3M

P/002N-30x5-3M

**a x b - L**

30x20x2-6M  
 40x20x2-6M  
 40x30x2,5-6M  
 50x30x2,5-6M  
 60x40x3-6M

P/101-10-3M  
 P/101-12-3M  
 P/101-14-3M

P/030-12x6-3M

**a x b - L**

PD/L-6M  
 34x31/42x1,5

P/111-12x12-3M  
 P/111-14x14-3M  
 P/111-16x16-3M

P/041N-30x8-3M

**a x b - L**

30x5

P/002-30x5

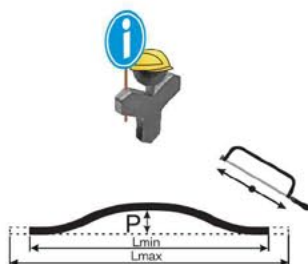

art. material		Lmin-Lmax (mm)	P (mm)	art. material		Lmin-Lmax (mm)	P (mm)
LO-100-30x5		800-1000	200	LO-100-P/002-30x5		800-1000	200
LO-130-30x5		1000-1300	200	LO-130-P/002-30x5		1000-1300	200
LO-170-30x5		1300-1700	200	LO-170-P/002-30x5		1300-1700	200
LO-200-30x5		1700-2000	200	LO-200-P/002-30x5		1700-2000	200
LO-240-30x5		1810-2400	200	LO-240-P/002-30x5		1810-2400	200
LO-295-30x5		2210-2950	200	LO-295-P/002-30x5		2210-2950	200
LO-385-30x5		2810-3850	200	LO-385-P/002-30x5		2810-3850	200
LO-440-30x5		3410-4400	250	LO-440-P/002-30x5		3410-4400	250
LO-580-30x5		4410-5800	300	LO-580-P/002-30x5		4410-5800	300

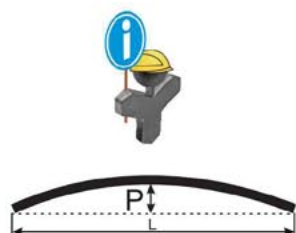

art. material		L (mm)	P (mm)	art. material		L (mm)	P (mm)
JO-194x20-30x5		1940	200	JO-194x20-P/002-30x5		1940	200
JO-245x20-30x5		2450	200	JO-245x20-P/002-30x5		2450	200

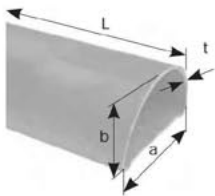



art. a x b



**P/010-40x5**  
L3000

**P/010-40x8**  
L3000



**U1-P/010-40x5**  
180x600,  
P/010, 40x5

**U1-P/010-40x8**  
180x600,  
P/010-40x8



**U2-P/010-40x5**  
50x85,  
P/010, 40x5

**U2-P/010-40x8**  
50x85,  
P/010-40x8



**U3-P/010-40x5**  
120x200,  
P/010, 40x5

**U3-P/010-40x8**  
120x200,  
P/010-40x8



**P/015-40x10**  
L3000

**P/015-45x12**  
L3000

**P/015-50x14**  
L3000



**U1-P/015-40x10**  
200x600,  
P/015-40x10



**U2-P/015-40x10**  
60x100,  
P/015-40x10



**U3-P/015-40x10**  
120x200,  
P/015-40x10

art. a x b



**P/014-40x10**  
L3000



**P/050-40x8**  
L3000



**P/002-40x5**  
L3000

**P/002-50x5**  
L300



**P/016-40x5**  
L3000



**P/018-40x5**  
L3000

**P/018-50x5**  
L3000



**WB/D42-L2000**

**WB/D42-L2500**

**WB/D42-L3000**



**P/021-48x20**  
t1,5, L3000



**P/022-48x20**  
t1,5, L3000



**P/024**  
t1,5, 54x54, L3000



**P/044-48x20**  
t1,5, L3000



**P/044-62x30**  
t1,5, L3000



**WB/40x40-L2000**

**WB/40x40-L2500**

**WB/40x40-L3000**

art. a x b



**P3/01-45**  
P/021, P/022, P/044



**P3/01-60**  
P/022, P/044



**Z1/25-black**  
90x60, M8, D50,  
black



**Z1/25-white**  
90x60, M8, D50,  
white



**Z1/15**  
230x110



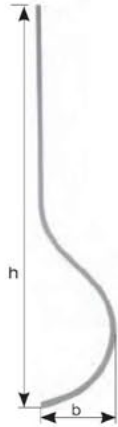

T13N-12x12



T10/027



T10/501



T10/715-1



T10/702-1



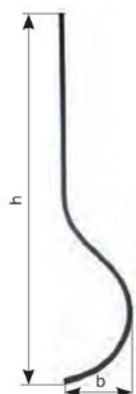

**T12-12x12**  
12x12,  
h900



**T12N-12x12**  
12x12,  
h900



**T13-12x12**  
12x12,  
h900



**T13N-12x12**  
12x12,  
h900



**T19-12x12**  
12x12,  
h900



**T19N-12x12**  
12x12,  
h900



**T17-12x12**  
12x12,  
h900



**T17N-12x12**  
12x12,  
h900



**T29/1-12x12**  
12x12,  
h900



**T29N/1-12x12**  
12x12,  
h900



**T14-12x12**  
12x12,  
h900



**T12N-T10/702-1**  
T10/702-1,  
h950



**T13N-P/035A-12**  
P/035A-12,  
h900



**T19N-P/035A-12**  
h 900



**T10/102T**  
P/035A-12,b162  
h900



**T11/102T**  
P/035A-12,b162  
h900



**T10/812A**  
P/035A-12, b160  
h900



**T10/820A**  
12x6,b330,  
h870



**T10/744**  
P/123-12,  
b145, h900



**F/68A**  
D12,  
h950



**T10/324T**  
P/123-12, b95,  
h900



**T11/324T**  
P/123-12, b95,  
h900



**T10/801A**  
12x12,b120  
h900



**T10/125-12x12**  
12x12  
h1000



**T10/027**  
12x12/12x6,b290  
h900



**T10/338A**  
12x12, b130,  
h900



**T10/740**  
12x12/12x6  
h950



**T10/741**  
P/035A-12, b170,  
h900



**T10/745**  
P/123-12, b160  
h900



**T10/776**  
P/035A-12, b85,  
h900



**T10/777-A**  
12x12, b160,  
h900



**T10/780**  
P/035A-12,b140  
h900



**T10/715-E**  
14x14, b36,  
h83



**T10/324S**  
12x12, h 900



**T10/823**  
900X280, 12x12



**T10/717A-E**  
12x12, h 200

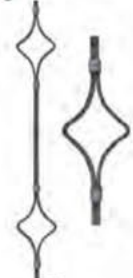

**T11/324S**  
12x12, h 900



**T10/824-L**  
740x315, 16x8



**T10/720A-E**  
14x14, h140, b25



**T10/334T**  
P/123-12, h900



**T10/824-R**  
740x320, 16x8



**T10/766-E-12x12**  
12x12, h 115



**T10/815**  
425x143, 12x6



**T10/821**  
P/035-12x12  
310x900



**T10/768A-E-12x12**  
14x14, h84,  
b33x33



**T10/826**  
12x12, h 950



**T10/753**  
D12, h900



**T10/769E-14x14**  
14x14, h145,  
b26x26



**T10/850**  
D12, h 900



**E2/151-900**  
P/035-12x12,  
h 900



**T10/789E**  
12x12, h200, b55



**T15/501T**  
12x12, h 900



**T94**  
h 1000



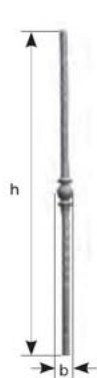

**T10/715-1**  
P/111-12,b35,W  
h1000



**T10/715-2**  
P/111-12,b35,  
h1000



**T10/702-1**  
P/035A-12,b35,  
h900



**T10/702-2**  
P/035A-12,b34,  
h900



**T10/786-1**  
D12,b26,  
h1000



**T10/786-2**  
D12,b26,  
h1000



**T10/787-1**  
D12,b28,  
h1000



**T10/787-2**  
D12,b28,  
h1000



**T10/760-1**  
P/035A-16,b35,  
h900



**T10/760-2**  
P/035A-16,b35,  
h900



**T10/734-1**  
D12,b35,  
h900



**T10/734-2**  
D12,b35,  
h900



**T12-O-1T**  
12x12,  
h900



**T12-O-2T**  
12x12,  
h900



**T10/785-1**  
D8,b25,  
h1000



**T10/785-2**  
D8,b25,  
h1000



**T10/705-1**  
D12,b27,  
h1000



**T10/705-2**  
D12,b27,  
h1000



**T10/735-1**  
2xD12,b50,  
h1000



**T10/735-2**  
2xD12,b50,  
h1000



**T10/759A-1**  
12x12,b25,  
h900



**T10/759A-2**  
12x12,b25,  
h900



**T10/501**  
12x12,b58,  
h900



**T11/501**  
12x12,b58,  
h900



**T10/501T**  
P/035A-12,b58,  
h900



**T11/501T**  
P/035A-12,b58,  
h900



**T10/702-25x25**  
P/035-25x25,b58,  
h1200



**T10/734A-D25**  
D25,b53,  
h1200



**T10/765-25x25**  
25x25,b33,  
h1200



**T10/715-25x25**  
P/111-25,b57,  
h1200



**T12-O-25x25**  
25x25,  
h1200



**T10/758T**  
P/111,h900



L/01-L



K1/50



N2/23-set



S1/20-T



V2/21



L/05-110



L/60



L/54



I4/10-Fe





**L/01-L**  
450x800,  
cast iron, black

**L/45**  
460x300x645,  
cast iron, black

**L/27-M**  
550x340x250  
cast iron, black

**L/27-V**  
650x450x330  
cast iron, black

**L/34**  
350x310, h695,  
cast iron, black

**L/35**  
300x260, h720,  
cast iron, black

**L/36**  
275x200, h475,  
cast iron, black

**L/37**  
410x370, h1000,  
cast iron, black

**L/05-110**  
L110, 1/2"  
Brass

**L/05-140**  
L140, 1/2"  
Brass

**L/63**  
L100, 1/2"  
Brass

**L/55**  
645x460x350,  
cast iron, black

**L/44**  
310x110x130,  
cast iron, black

**L/60**  
b 260,  
cast iron, black

**L/54**  
470x160x210,  
cast iron, black



**N1/09-L**  
h810,  
cast iron, black

**N1/09-R**  
h810,  
cast iron, black

**N2/09**  
670x580,  
cast iron, black

**N1/13**  
h665, b440,  
cast iron

**O6/30A**  
140x115,  
Fe

**K1/49**  
h700,  
natural

**K4/70-140**  
140x110,  
black

**K4/70-230**  
230x175,  
black

**D3/40L-350**  
350x180x3,  
black

**D3/40R-350**  
345x180x3,  
black

**I1/63**  
h1400xD360,  
natural

**I4/10-Fe**  
h270,b135, D6



**V1/21**  
1300x600,  
Cu



**V3/02**  
1000x850,  
black



**S1/13-T**  
460x400,  
Fe, black



**S1/20-T**  
360xD330,  
Fe, black



**S1/20-T-1/2**  
350x150,  
Fe, black



**S1/16-T**  
630xD330,  
patina



**S1/24**  
530x360



**S1/03T**  
460xD240, patina



**J9/01-18x18**  
18x18x25  
**J9/01-20x20**  
20x20x32  
**J9/01-28x28**  
28x28x35



**J9/01-D15**  
D15x43  
**J9/01-D20**  
D20x43

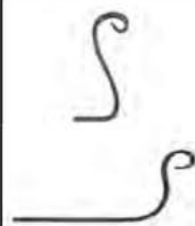

**E/317J-12x12**  
280x150, 12x12

**E/317J-135-12x6**  
135x260, 12x6





**K1/40**  
h 1000



**K1/42**  
h 1000



**K2/10**  
670X400



**K4/4.29**  
h1600, b800



**K4/69-125**  
125x150  
**K4/69-150**  
150x200  
**K4/69-200**  
200x275



**L/04-L**  
cast iron black



**L/39**  
h1300,  
cast iron black



**L/29**  
h920, Al, black



**L/46**  
300x260, h710,  
cast iron



**N2/23-set**  
Al-set, 2x chair, 1x table, black



**O6/36**  
65X26/3,5x3,5  
L1000

**01**

**V5/24-0,1,9**  
h120, t3



**V2/21**  
255x410,  
Al, black



**V2/21-Cu**  
255x410,  
Al, color Cu



**V2/24**  
510x410, Zn



**V2/31**  
280x280,  
cast iron, black



**V2/45**  
330x350x150



**V2/47**  
450x320x100  
inox, AISI 304



**D3/48-650**  
400x650,  
b50, t5, d16



**D3/51-1000**  
L1000,  
b50, t5, d18,5  
**D3/51-1200**  
L1200,  
b60, t6, d20,5

**NOSAČ STAKLA**

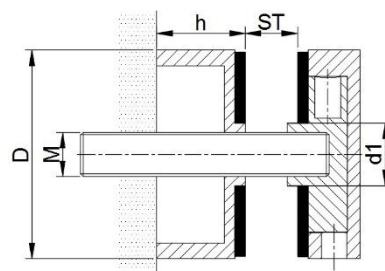
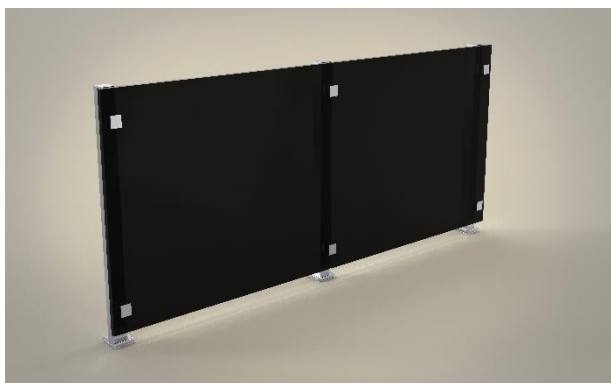

MODEL	FINISH	STAKLO	D	d1	M	h
GS 100-40-00	SATINIRANO, POLIRANO	8-20	40	18	10	10-30

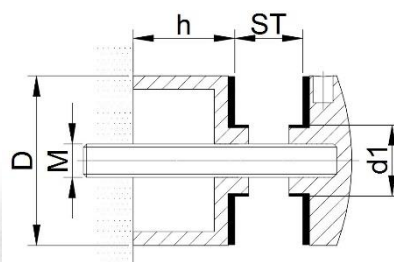
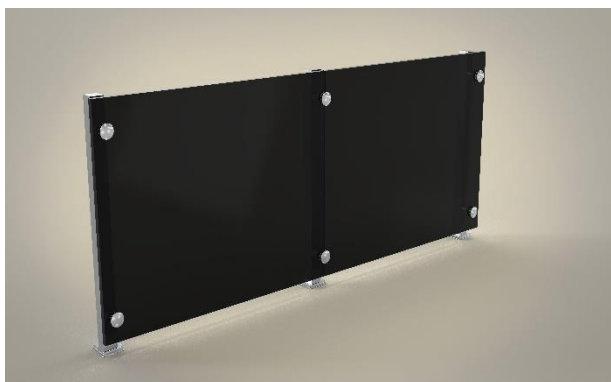

- fiksni nosač stakla

MODEL	FINISH	STAKLO	D	d1	M	h
GS 101-30	SATINIRANO, POLIRANO	8-16	30	14	8	10-30
GS 102-40		8-16	40	14	8	10-30
GS 103-50		8-20	50	22	10	10-30

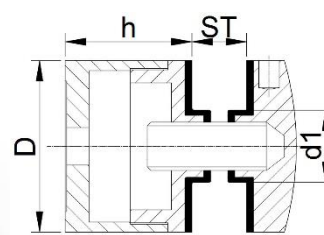
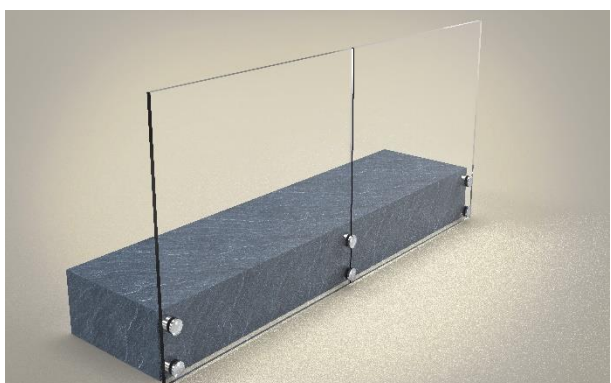

- regulirajući nosač stakla

MODEL	FINISH	STAKLO	D	d1	h
GS 8105	SATINIRANO, POLIRANO	8-20	50	22	27-250

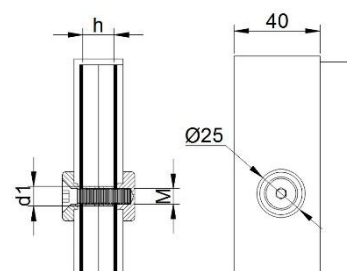

MODEL	FINISH	STAKLO	d1	M
GSA 40-25	SATINIRANO, POLIRANO	8-16	14	8



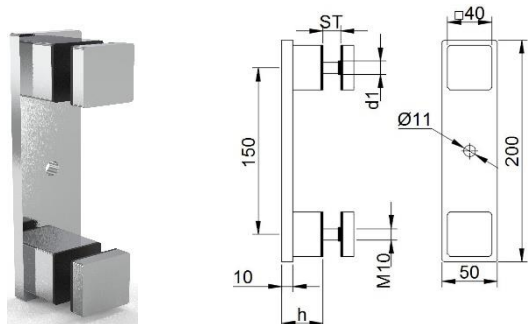

MODEL	FINISH	STAKLO	d1	M	h
GS 200-50	SATINIRANO	8-20	18	10	20-40

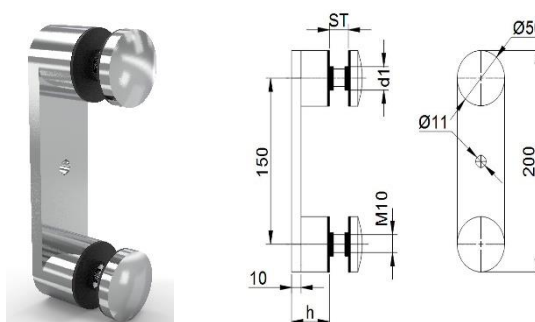

MODEL	FINISH	STAKLO	d1	M	h
GSO 200-50	SATINIRANO	8-20	22	10	20-40



- A/2100-042

- A/2000-042



- standardni nosač stakla

MODEL	FINISH	STAKLO	Ø
A/2000-042	SATINIRANO, POLIRANO	6-16	40 / 42,4 / 50
A/2100-042			



- SF 101-30

- SF 102-30

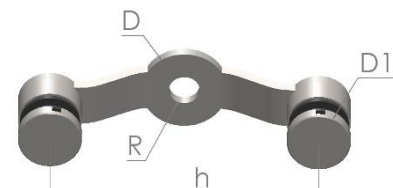
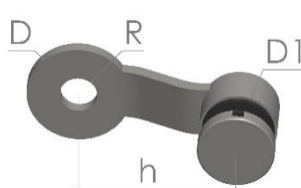

MODEL	FINISH	STAKLO	D1	D	h	R
SF 101-30	SATINIRANO	8-17,52	30	40	70	14,5
SF 102-30		8-17,52	30	40	140	14,5

**NOSAČ STAKLA**

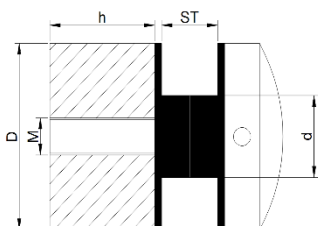
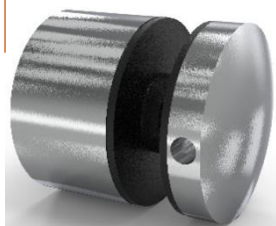

- fiksni nosač stakla

MODEL	FINISH	STAKLO	D	d	h	M
GSF-30	SATINIRANO, POLIRANO	8-12	30	14	30	8
GSF-40		8-16	40	14	30	8
GSF-50		8-20	50	22	30	10

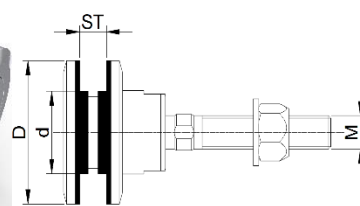
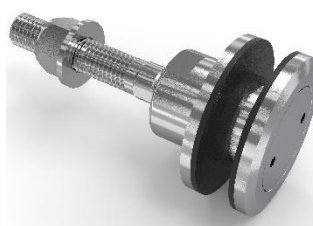

- zglobni nosač stakla

MODEL	FINISH	STAKLO	D	d	M
GSD-60	SATINIRANO	8-16	60	35	14

**NOSAČ RUKOHVATA - STAKLO**

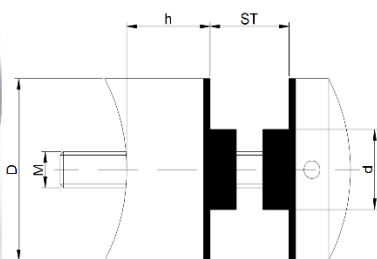
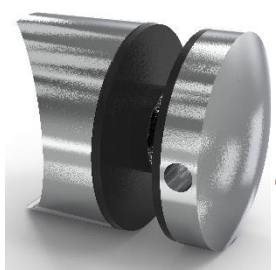

- fiksni nosač stakla – za cijev

MODEL	FINISH	STAKLO	D	d	h	M
GSB-50	SATINIRANO, POLIRANO	8-20	50	22	10	10

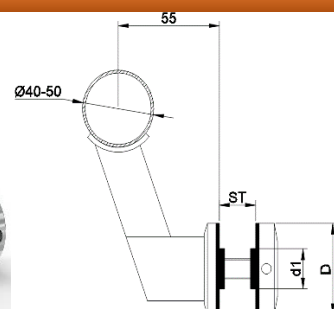

MODEL	FINISH	STAKLO	D	d1
GSE-30	SATINIRANO	8-20	30	14

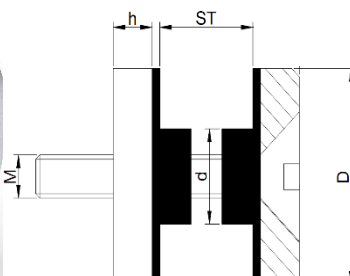
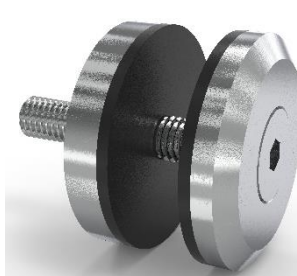

- fiksni nosač stakla

MODEL	FINISH	STAKLO	D	d	h	M
GSC-30	SATINIRANO, POLIRANO	8-12	30	14	5-10	8
GSC-40		8-16	40	14	5-10	8
GSC-50		8-20	50	22	5-10	10

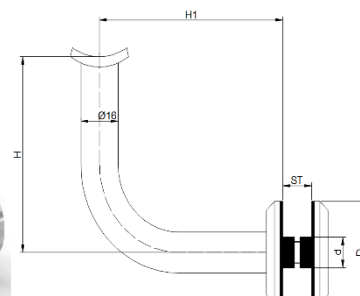

MODEL	FINISH	STAKLO	D	d	H	H1
GSG-30	SATINIRANO, POLIRANO	8-20	30	14	73	73
GSG-40		8-20	40	14	73	73

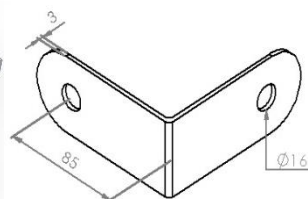

- kutni stabilizator stakla

MODEL	STAKLO	D	d
GSC-30/2	8-20	30	14
GSC-40/2	8-16	40	14
GSC-50/2	8-12	50	22

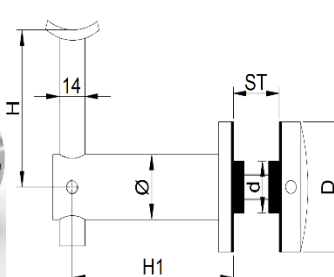

MODEL	FINISH	STAKLO	D	d	H	H1	Ø
GSH-30	SATINIRANO, POLIRANO	8-20	30	14	80	73	22
GSH-40		8-20	40	14	80	73	22
GSH-50		8-20	50	22	80	73	25